



LINE 147
 Francesco Rota
 2009

Wall lamp giving indirect light (up & down) in transparent oval Pyrex glass. Structure and reflecting screen in polished aluminium.

DIMENSIONS

MATERIALS

COLORS

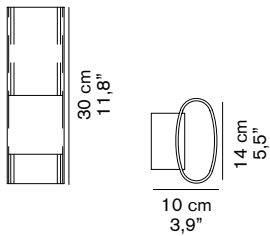

aluminium/pyrex glass

transparent

BULBS

MARKS

FURTHER INFORMATION

2 x max 40 W - G9



 equipped without bulb

Note: lamp compatible with LED bulbs (according to the market availability and without changes to the standard product)

PACKAGING

TYPE

PHOTOMETRIC CURVE



dimensions 22x16x51 cm / 8,7"x6,3"x20,1"
 volume 0,0179 m³ / 0,63 ft³
 weight 2,5 kg / 5,51 lb

indoor - wall lamp

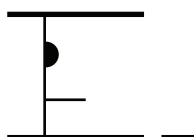



LINE 149

Francesco Rota
2009

Wall lamp giving indirect light (up & down) in transparent oval Pyrex glass. Structure and reflecting screen in polished aluminium.

DIMENSIONS

MATERIALS

COLORS

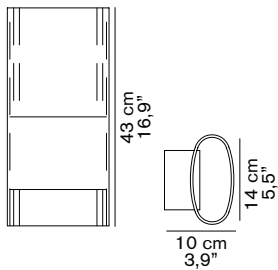

aluminium/pyrex glass

transparent

BULBS

MARKS

FURTHER INFORMATION

2 x max 40 W - G9



 equipped without bulb

Note: lamp compatible with LED bulbs (according to the market availability and without changes to the standard product)

PACKAGING

TYPE

PHOTOMETRIC CURVE



dimensions 64x22x16 cm / 25,2"x8,7"x6,3"
volume 0,0225 m³ / 0,80 ft³
weight 3 kg / 6,61 lb

indoor - wall lamp

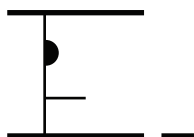

Line Wall Lamp

Small

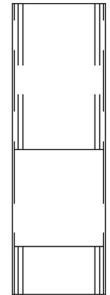

30 cm
11,8"

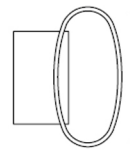

10 cm
3,9"

14 cm
5,5"

Large

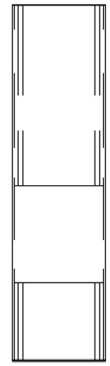

43 cm
16,9"

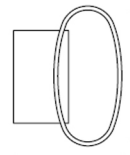

10 cm
3,9"

14 cm
5,5"

ISTRUZIONI PER IL MONTAGGIO MOUNTING INSTRUCTIONS INSTRUCTION POUR LE MONTAGE MONTAGEANLEITUNG

O luce S.r.l.

Via Brescia, 2 - 20097 San Donato Milanese (Mi) - Italia
Tel. +39 2 9849 1435 - Fax +39 2 9849 0779
http://www.oluce.com - e-mail : info@oluce.com

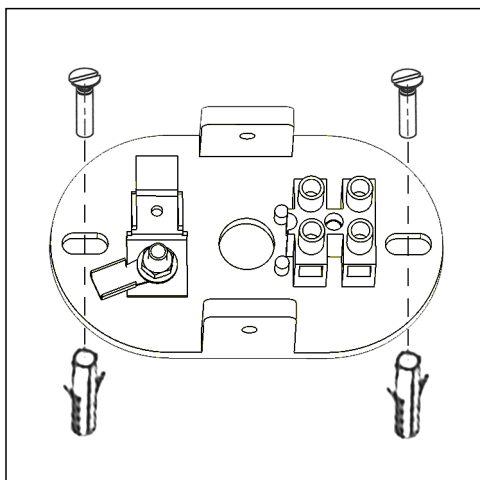

fig. 1

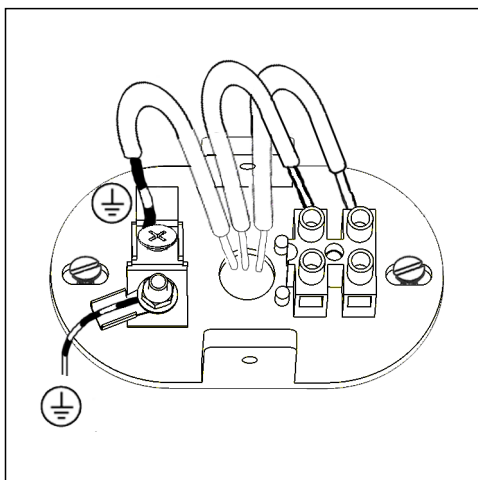

fig. 2

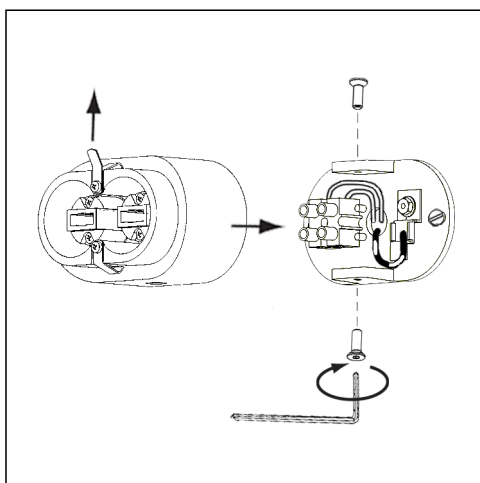

fig. 3

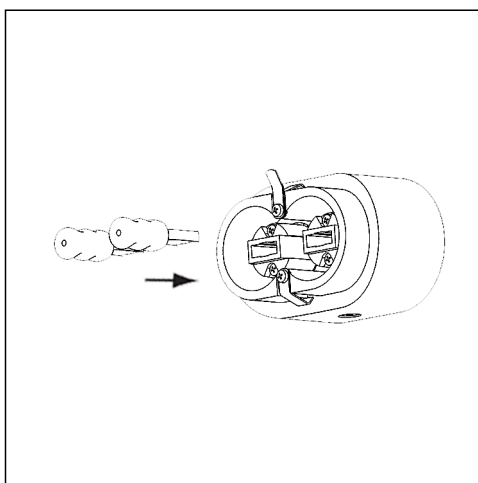

fig. 4

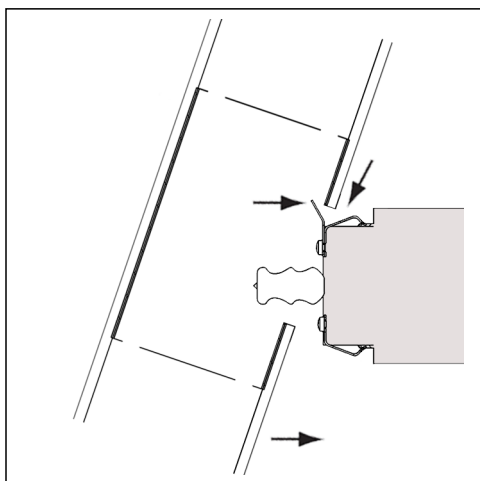

fig. 5

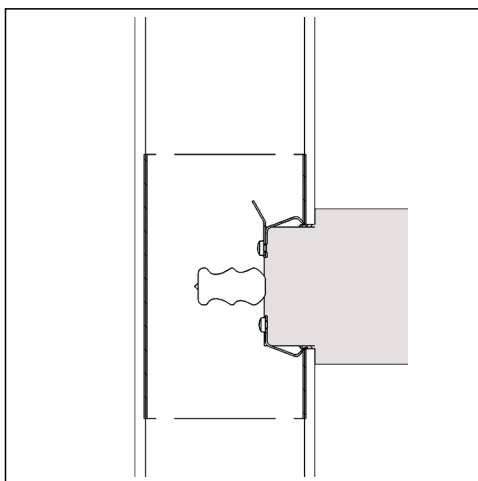

fig. 6

147 - 147/C - 2 x max 40W(G9) o 2 x max 7W(G9 fluo)
↑ 30 → 10 ↔ 14 cm

149 - 149/C - 2 x max 40W(G9) o 2 x max 7W(G9 fluo)
↑ 43 → 10 ↔ 14 cm

IT - Per la sicurezza elettrica ed il corretto montaggio della lampada seguire la sequenza delle immagini.

Disinserire la rete di alimentazione prima di intervenire sulla lampada. Per pulire la lampada non usare detergenti abrasivi.

EN - For electrical safety and a correct lamp assembly, follow the sequence of the pictures. **Cut off the electrical current before any intervention on the lamp.** Do not use abrasive detergents when cleaning the lamp.

FR - Pour la sécurité électrique et un montage correct de la lampe, suivre la séquence des images. **Débrancher le courant électrique avant d'intervenir sur la lampe.** Ne pas employer de détergents abrasifs pour nettoyer la lampe.

DE - Zwecks der elektrischen Sicherheit und zur korrekten Montage, die Reihenfolge der Abbildungen verfolgen. **Vor Handhabung der Lampe, elektrischen Strom ausschalten.** Keine ätzenden Reinigungsmittel zum Säubern der Lampe verwenden.



CLASSE I - CLASS I - CLASSE I - KLASSE I
Terra • Ground • Terre • Sicherheitserdnh



IT - Non montare su superfici normalmente infiammabili.

EN - Not be mounted on normally flammable surfaces.

FR - Pas être monté sur des surfaces normalement inflammables.

DE - Nicht auf normal entflammbaren Oberflächen montiert werden.



IT - Questo prodotto non deve essere smaltito come un rifiuto municipale misto, effettuare una raccolta separata.

EN - This product must not be discarded as the responsibility of the City sanitation, it must be gathered together separately and discarded.

FR - Ce produit ne doit pas être mis avec les ordures municipales, il faut effectuer un ramassage séparé.

DE - Dieses Produkt darf nicht als Gemeindekehricht entsorgt werden. Entsorgung muss getrennt erfolgen.